

# Phillips (Formerly Pla-Cor<sup>®</sup>) Corner & Transition Cap Cross Reference



## Phillips Acquired Pla-Cor<sup>®</sup> Corner & Transition Cap Assets



| Pla-Cor <sup>®</sup> Part | Phillips Part Number | Part Description                                 | Product Image | Additional Information  |
|---------------------------|----------------------|--|---------------|---|
| 125<br>(old 443)          | CAP125               | 125R BULLNOSE 3-WAY CORNER CAP 1-1/2"            |               | Specialty product designed to finish where 3 Outside 1-1/2" Bullnose Corners intersect. This product does not feature alignment tabs for those who prefer it.                     |
| 134                       | CAP134               | BULLNOSE 3-WAY SPLAY CORNER CAP 3/4"             |               | Designed finish where 2 Outside 3/4" Bullnose Corners and 1 Outside 3/4" Bullnose Splay Corner intersect. Does not feature alignment tabs for those who prefer it.                |
| 135                       | CAP135               | BULLNOSE 3-WAY SPLAY CORNER CAP 3/4"             |               | <b>This is the Primary 3/4" 3-Way Splay Corner Cap used by most.</b> Designed to finish where 2 Outside 3/4" Bullnose Corners and 1 Outside 3/4" Bullnose Splay Corner intersect. |
| 2 In 1 Out<br>135 Degree  | CAP136               | BULLNOSE INSIDE CORNER CAP 2 IN 1 OUT SPLAY 3/4" |               | Designed to finish where 2 Inside 3/4" Bullnose Corners intersect with 1 Outside 3/4" Bullnose Splay Corner.  |

# Phillips (Formerly Pla-Cor<sup>®</sup>) Corner & Transition Cap Cross Reference



## Phillips Acquired Pla-Cor<sup>®</sup> Corner & Transition Cap Assets



| Pla-Cor <sup>®</sup> Part | Phillips Part Number | Part Description                                    | Product Image  | Additional Information   |
|---------------------------|----------------------|---|--|--|
| 2 In 1 Out<br>BN90        | CAP137               | BULLNOSE INSIDE CORNER CAP<br>2 IN 1 OUT 3/4"       | <p>Inside 90°      Inside 90°<br/>Outside 90°<br/><i>Drawing Not to Scale</i></p>  | Designed to finish where 2 Inside 3/4" Bullnose Corners intersect with 1 Outside 3/4" Bullnose Corner.     |
| 2 Out 1 In<br>BN90        | CAP138               | BULLNOSE INSIDE CORNER CAP<br>2 OUT 1 IN 3/4"       | <p>Outside 90°      Outside 90°<br/>Inside 90°<br/><i>Drawing Not to Scale</i></p> | Designed to finish where 1 Inside 3/4" Bullnose Corner intersects with 2 Outside 3/4" Bullnose Corners.    |
| 3 In 0 Out<br>135 Degree  | CAP139               | BULLNOSE INSIDE CORNER CAP<br>3 IN 0 OUT SPLAY 3/4" | <p>Inside 90°      Inside 90°<br/>Inside Splay<br/><i>Drawing Not to Scale</i></p> | Designed to finish where 2 Inside 3/4" Bullnose Corners and 1 Inside 3/4" Bullnose Splay Corner intersect. |
| 3 In 0 Out<br>BN90<br>583 | CAP583               | BULLNOSE INSIDE CORNER CAP<br>3 IN 0 OUT 3/4"       | <p>Inside 90°      Inside 90°<br/>Inside 90°<br/><i>Drawing Not to Scale</i></p>   | Designed to finish where 3 Inside 3/4" Bullnose Corners intersect.   |

# Phillips (Formerly Pla-Cor<sup>®</sup>) Corner & Transition Cap Cross Reference



## Phillips Acquired Pla-Cor<sup>®</sup> Corner & Transition Cap Assets



| Pla-Cor <sup>®</sup> Part | Phillips Part Number | Part Description                                       | Product Image   | Additional Information   |
|---------------------------|----------------------|--|---|--|
| 2 Out 1 In<br>135 Degree  | CAP141               | BULLNOSE INSIDE<br>CORNER CAP<br>2 OUT 1 IN SPLAY 3/4" | <p>Outside 90°      Outside 90°<br/>Inside Splay<br/><i>Drawing Not to Scale</i></p>  | Designed to finish where 2 Outside 3/4" Bullnose Corners intersect with 1 Inside 3/4" Bullnose Splay Corner.     |
| 145                       | CAP145               | BULLNOSE 3-WAY SPLAY<br>CORNER CAP 1/2"                | <p>Outside 90°      Outside 90°<br/>Outside Splay<br/><i>Drawing Not to Scale</i></p> | Designed to finish where 2 Outside 1/2" Bullnose Corners and 1 Outside 1/2" Bullnose Splay Corner intersect.     |
| 187                       | CAP187               | BULLNOSE 3-WAY SPLAY<br>CORNER CAP 1-1/2"              | <p>Outside 90°      Outside 90°<br/>Outside Splay<br/><i>Drawing Not to Scale</i></p> | Designed to finish where 2 Outside 1-1/2" Bullnose Corners and 1 Outside 1-1/2" Bullnose Splay Corner intersect. |
| 190                       | CAP190               | 3-WAY SPLAY  | <p>Outside 90°      Outside 90°<br/>Outside Splay<br/><i>Drawing Not to Scale</i></p> | Designed to Finish 2 Square Corners and 1 Splay Corner.  |

# Phillips (Formerly Pla-Cor<sup>®</sup>) Corner & Transition Cap Cross Reference



## Phillips Acquired Pla-Cor<sup>®</sup> Corner & Transition Cap Assets



| Pla-Cor <sup>®</sup> Part | Phillips Part Number | Part Description                        | Product Image | Additional Information   |
|---------------------------|----------------------|---|---------------|--|
| 125R<br>BN 135            | CAP197               | 125R BULLNOSE 3-WAY<br>SPLAY 1-1/2"     |               | Specialty product designed to finish where 2 Outside 1-1/2" Bullnose Corners and 1 Outside 1-1/2" Bullnose Splay Corner intersect. |
| 235                       | CAP235               | BULLNOSE 2-WAY SPLAY<br>CORNER CAP 3/4" |               | Designed to finish where 2 Outside 3/4" Bullnose Splay Corners intersect.  |
| 245                       | CAP245               | BULLNOSE 2-WAY<br>CORNER CAP 1/2"       |               | Designed to finish where 2 Outside 1/2" Bullnose Corners intersect.  |
| 246                       | CAP246               | BULLNOSE 2-WAY<br>CORNER CAP 1/2"       |               | Designed to finish where 2 Outside 1/2" Bullnose Corners intersect. Does not feature alignment tabs for those who prefer it.       |

# Phillips (Formerly Pla-Cor<sup>®</sup>) Corner & Transition Cap Cross Reference



## Phillips Acquired Pla-Cor<sup>®</sup> Corner & Transition Cap Assets

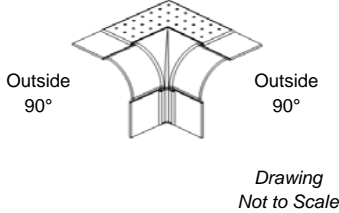
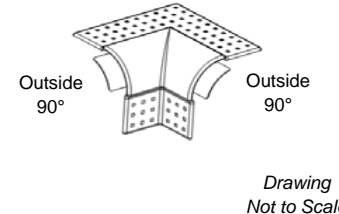
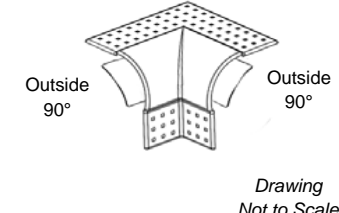
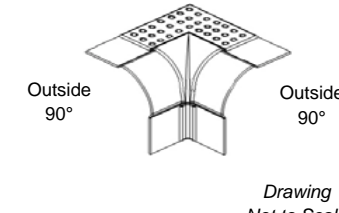

| Pla-Cor <sup>®</sup> Part | Phillips Part Number | Part Description                      | Product Image   | Additional Information   |
|---------------------------|----------------------|---------------------------------------|---|--|
| 284                       | CAP284               | BULLNOSE 2-WAY CORNER CAP 3/4"        |  <p>Outside 90°      Outside 90°</p> <p><i>Drawing Not to Scale</i></p>   | Designed to finish where 2 Outside 3/4" Bullnose Corners intersect. Does not feature alignment tabs for those who prefer it.   |
| 285                       | CAP285               | BULLNOSE 2-WAY CORNER CAP 3/4"        |  <p>Outside 90°      Outside 90°</p> <p><i>Drawing Not to Scale</i></p>   | Designed to finish where 2 Outside 3/4" Bullnose Corners intersect. This is the Primary 3/4" 2-Way Corner Used by most.        |
| 287                       | CAP287               | BULLNOSE 2-WAY CORNER CAP 1-1/2"      |  <p>Outside 90°      Outside 90°</p> <p><i>Drawing Not to Scale</i></p>  | Designed to finish where 2 Outside 1-1/2" Bullnose Corners intersect.  |
| 125R<br>BN 2-WAY          | CAP297               | 125R BULLNOSE 2-WAY CORNER CAP 1-1/2" |  <p>Outside 90°      Outside 90°</p> <p><i>Drawing Not to Scale</i></p> | Designed to finish where 2 Outside 1-1/2" Bullnose Corners intersect. Does not feature alignment tabs for those who prefer it. |

# Phillips (Formerly Pla-Cor<sup>®</sup>) Corner & Transition Cap Cross Reference



## Phillips Acquired Pla-Cor<sup>®</sup> Corner & Transition Cap Assets



| Pla-Cor <sup>®</sup> Part | Phillips Part Number | Part Description                 | Product Image | Additional Information   |
|---------------------------|----------------------|----------------------------------|---------------|--|
| 345                       | CAP345               | BULLNOSE 3-WAY CORNER CAP 1/2"   |               | Designed to finish where 3 Outside 1/2" Bullnose Corners intersect.  |
| 346                       | CAP346               | BULLNOSE 3-WAY CORNER CAP 1/2"   |               | Designed to finish where 3 Outside 1/2" Bullnose Corners intersect. Does not feature alignment tabs for those who prefer it. |
| 384                       | CAP384               | BULLNOSE 3-WAY CORNER CAP - 3/4" |               | Designed to finish where 3 Outside 3/4" Bullnose Corners intersect. Does not feature alignment tabs for those who prefer it. |
| 385                       | CAP385               | BULLNOSE 3-WAY CORNER CAP 3/4"   |               | Designed to finish where 3 Outside 3/4" Bullnose Corners intersect. This is the Primary 3/4" 3-Way Corner used by most       |

# Phillips (Formerly Pla-Cor<sup>®</sup>) Corner & Transition Cap Cross Reference



## Phillips Acquired Pla-Cor<sup>®</sup> Corner & Transition Cap Assets

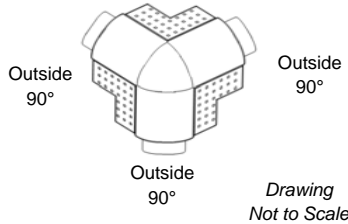
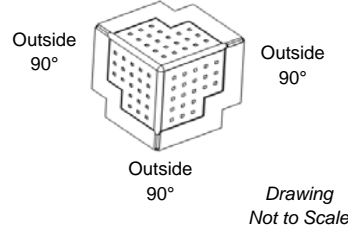
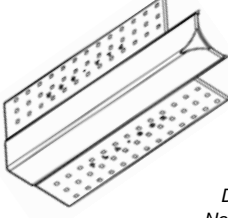
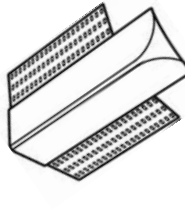

| Pla-Cor <sup>®</sup> Part | Phillips Part Number | Part Description                 | Product Image  | Additional Information   |
|---------------------------|----------------------|----------------------------------|--|--|
| 387                       | CAP387               | BULLNOSE 3-WAY CORNER CAP 1-1/2" |  <p>Outside 90°      Outside 90°<br/>Outside 90°<br/><i>Drawing Not to Scale</i></p> | Designed to finish where 3 Outside 1-1/2" Bullnose Corners intersect.                                      |
| 390                       | CAP390               | 90 DEGREE 3-WAY CORNER CAP       |  <p>Outside 90°      Outside 90°<br/>Outside 90°<br/><i>Drawing Not to Scale</i></p> | Designed to finish where 3 Outside 90° Corner intersect.   |
| 590                       | TRN590               | OVERLAP TRANSITION CAP 1/2"      |  <p><i>Drawing Not to Scale</i></p>   | Designed to transition from 1/2" Bullnose to 90°   |
| 690                       | TRN690               | OVERLAP TRANSITION CAP 3/4"      |  <p><i>Drawing Not to Scale</i></p>  | Designed to transition from 3/4" Bullnose to 90°. Does not feature alignment tabs for those who prefer it. |



# Phillips (Formerly Pla-Cor<sup>®</sup>) Corner & Transition Cap Cross Reference



## Phillips Acquired Pla-Cor<sup>®</sup> Corner & Transition Cap Assets

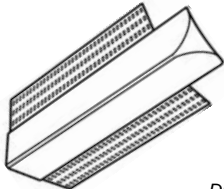
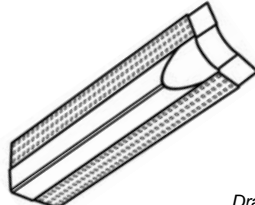
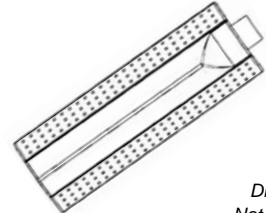
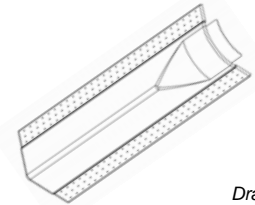

| Pla-Cor <sup>®</sup> Part | Phillips Part Number | Part Description                  | Product Image   | Additional Information   |
|---------------------------|----------------------|-----------------------------------|---|--|
| 790                       | TRN790               | LARGE OVERLAP TRANSITION CAP 3/4" |  <p><i>Drawing<br/>Not to Scale</i></p>   | Designed to transition from 3/4" Bullnose to 90°. Does not feature alignment tabs for those who prefer it. |
| 8490                      | TRN8490              | JUMBO TRANSITION CAP 3/4"         |  <p><i>Drawing<br/>Not to Scale</i></p>   | Designed to transition from 3/4" Bullnose to 90°. Does not feature alignment tabs for those who prefer it. |
| 8590                      | TRN8590              | JUMBO TRANSITION CAP 3/4"         |  <p><i>Drawing<br/>Not to Scale</i></p>  | Designed to transition from 3/4" Bullnose to 90°. This is the Primary Transition Cap Used by most.         |
| 8790                      | TRN8790              | JUMBO TRANSITION CAP 1-1/2"       |  <p><i>Drawing<br/>Not to Scale</i></p> | Designed to transition from 1-1/2" Bullnose to 90°.  |



# Phillips (Formerly Pla-Cor<sup>®</sup>) Corner & Transition Cap Cross Reference



## Phillips Acquired Pla-Cor<sup>®</sup> Corner & Transition Cap Assets

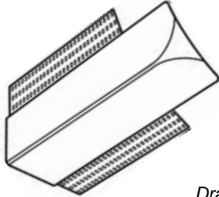

| Pla-Cor <sup>®</sup><br>Part | Phillips<br>Part Number | Part Description                       | Product Image   | Additional Information   |
|------------------------------|-------------------------|--|---|--|
| 890                          | TRN890                  | LARGE OVERLAP TRANSITION<br>CAP 1-1/2" |  <p><i>Drawing<br/>Not to Scale</i></p> | Designed to transition from 1-1/2" Bullnose to 90°. Does not feature alignment tabs for those who prefer it. |

### Other Profiles Available

Please contact your Phillips Sales Representative for more information.

Phillips Manufacturing Co. acquired the corner and transition cap assets of Pla-Cor in March, 2010. All cap products formerly produced by Pla-Cor are now available from Phillips. For more information please visit [www.phillipsmfg.com](http://www.phillipsmfg.com), call 800.822.5055 or contact your Phillips sales representative.